

NOTE: DIMENSIONS IN [ ] ARE INCH EQUIVALENTS.

UNLESS OTHERWISE SPECIFIED:  
 ALL DIMENSIONS IN MILLIMETERS  
 GENERAL TOLERANCES:  
 X.XX ± 0.25  
 X.X ± 1.0  
 X ± 1.5  
 ANGLES ± 0°30'

SURFACE FINISH  
 ✓ MAX.

DO NOT SCALE.  
 THIS ASSEMBLY OR PART MUST  
 COMPLY WITH PEP-RML-001.  
 REFERENCE CAD MODEL FOR  
 UNSPECIFIED DIMENSIONS.

THIRD ANGLE PROJECTION



MAJOR ○ = 0  
 CRITICAL ⊕ = 0  
 CHARACTERISTICS COMPLY WITH  
 KPS-60022

DRAWN BY AZE DATE: 04NOV2020  
 APPROVED BY KJB

SCALE: NA SHEET SIZE: B SHEET 1 OF 5  
 TITLE:  
**DIMENSION PRINT,**  
**14/18/20RCA**  
 DWG NO.: **ADV-9746**

REV	DATE	CHANGE NUMBER	ON COMPOSITE DWGS, SEE PART NO. FOR REVISION LEVEL □ INDICATES PART NUMBERS AFFECTED BY LATEST DRAWING REVISION	BY
-	04NOV2020	CT207992	NEW DRAWING	AZE

14/18/20RCA

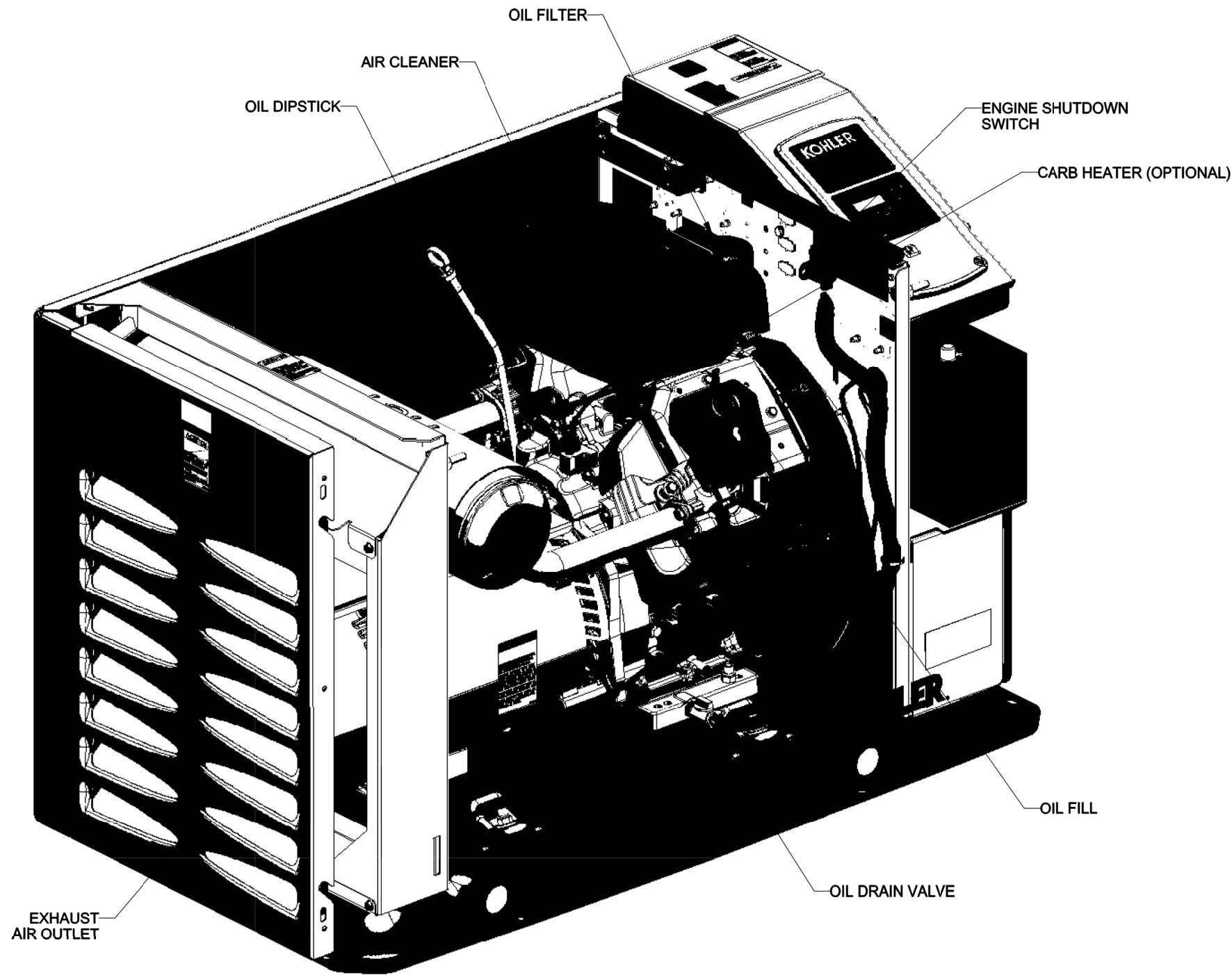

REV	DATE	CHANGE NUMBER	ON COMPOSITE DWGS, SEE PART NO. FOR REVISION LEVEL □ INDICATES PART NUMBERS AFFECTED BY LATEST DRAWING REVISION	BY
-	04NOV2020	CT207992	NEW DRAWING	AZE

14/18/20RCA

UNLESS OTHERWISE SPECIFIED:  
ALL DIMENSIONS IN MILLIMETERS  
GENERAL TOLERANCES:  
X.XX ± 0.25  
X.X ± 1.0  
X ± 1.5  
ANGLES ± 0°30'

SURFACE FINISH  
✓ MAX.

THIRD ANGLE PROJECTION

MAJOR ⌀ = 0  
CRITICAL ⌀ = 0  
CHARACTERISTICS COMPLY WITH  
KPS-60022

DRAWN BY AZE DATE: 04NOV2020  
APPROVED BY KJB

DO NOT SCALE.  
THIS ASSEMBLY OR PART MUST  
COMPLY WITH PEP-RML-001.  
REFERENCE CAD MODEL FOR  
UNSPECIFIED DIMENSIONS.

**KOHLER.**  
KOHLER, WISCONSIN 53044

SCALE: NA SHEET SIZE: B SHEET 2 OF 5

TITLE:  
**DIMENSION PRINT,  
14/18/20RCA**

DWG NO.: **ADV-9746**

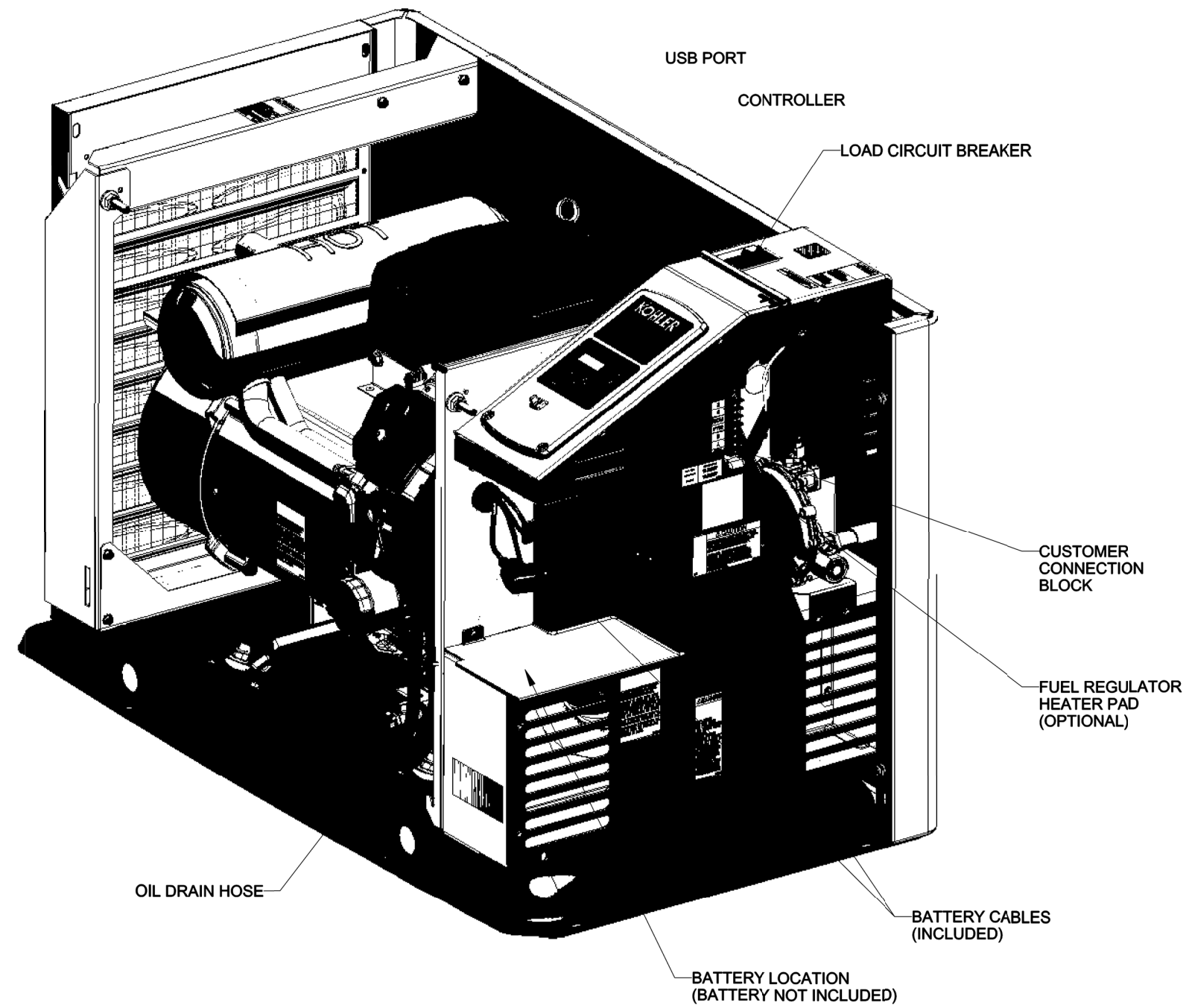
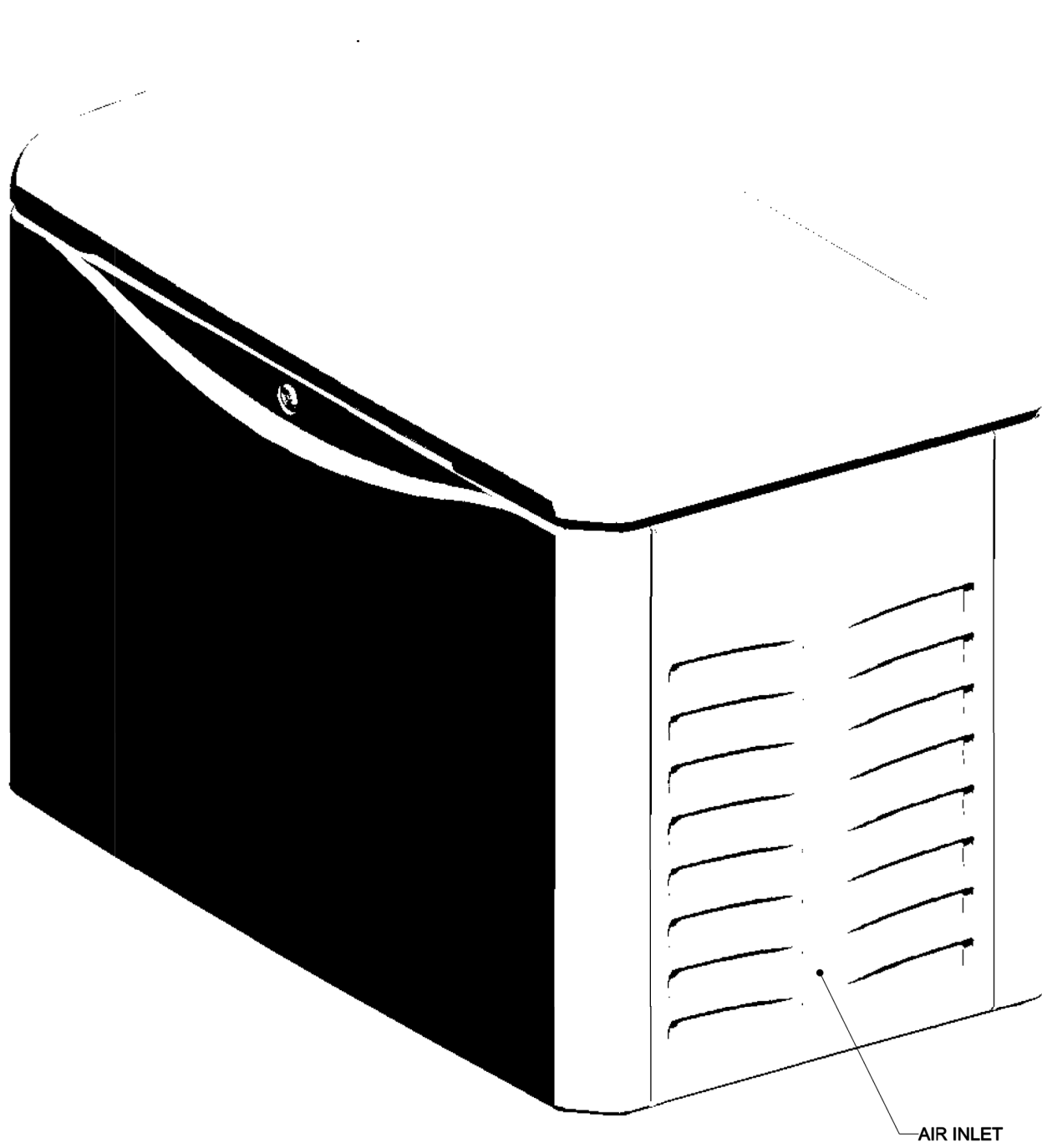

REV	DATE	CHANGE NUMBER	ON COMPOSITE DWGS, SEE PART NO. FOR REVISION LEVEL □ INDICATES PART NUMBERS AFFECTED BY LATEST DRAWING REVISION	BY
-	04NOV2020	CT207992	NEW DRAWING	AZE

UNLESS OTHERWISE SPECIFIED:  
ALL DIMENSIONS IN MILLIMETERS  
GENERAL TOLERANCES:  
X.XX ± 0.25  
X.X ± 1.0  
X ± 1.5  
ANGLES ± 0°30'

SURFACE FINISH  
MAX.

THIRD ANGLE PROJECTION

MAJOR ⌀ = 0  
CRITICAL Ⓢ = 0  
CHARACTERISTICS COMPLY WITH KPS-80022

DRAWN BY AZE DATE: 04NOV2020  
APPROVED BY KJB

DO NOT SCALE.  
THIS ASSEMBLY OR PART MUST COMPLY WITH PEP-RML-001.  
REFERENCE CAD MODEL FOR UNSPECIFIED DIMENSIONS.

**KOHLER.**  
KOHLER, WISCONSIN 53044

SCALE: NA SHEET SIZE: B SHEET 3 OF 5

TITLE:  
**DIMENSION PRINT,  
14/18/20RCA**

DWG NO.: **ADV-9746**

14/18/20RCA

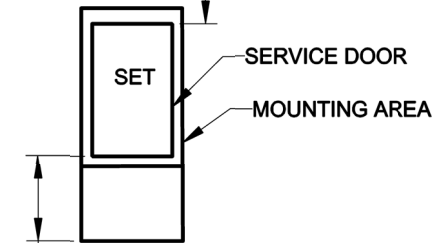
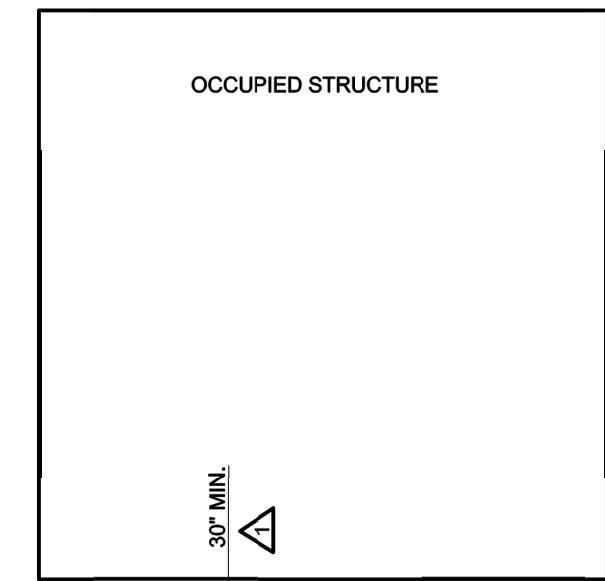

4 FT. CLEARANCE AT EXHAUST END

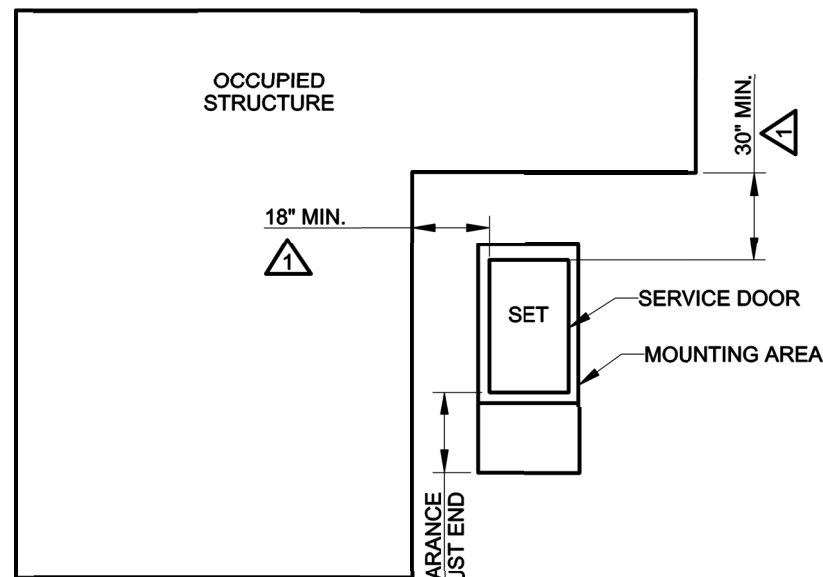
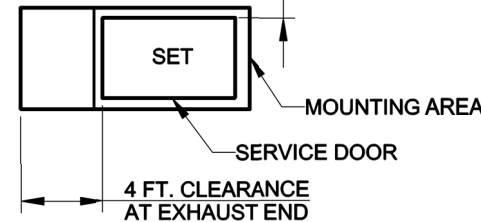
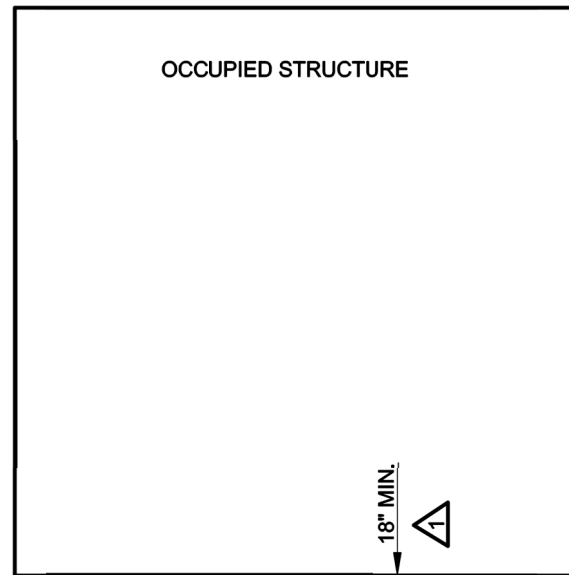

18" MIN.

4 FT. CLEARANCE AT EXHAUST END

**NOTE:**

△ THE RECOMMENDED DISTANCE FROM A STRUCTURE IS DEPENDENT ON STATE AND LOCAL CODES. PRODUCT HAS BEEN DEMONSTRATED IN ACCORDANCE WITH NFPA 37 SECTION 4.1.4 BY A THIRD PARTY TEST FACILITY TO THE DIMENSIONS SHOWN.

**ACCEPTABLE**

- 1) EXHAUST IS AIMED AWAY OR PARALLEL TO STRUCTURE.
- 2) EXHAUST IS NOT DIRECTED AT PLAY AREAS, PATIOS OR OTHER AREAS WHERE PEOPLE CONGREGATE.
- 3) THE NEAREST WINDOW, VENT, DOOR OR SIMILAR STRUCTURE OPENING IS AT LEAST 5 FEET FROM THE EXHAUST END OF THE SET.
- 4) SET HAS PROPER OFFSET FROM STRUCTURE.
- 5) WINDOWS & DOORS ON ADJACENT WALLS ARE CLOSED.
- 6) FURNACE AND OTHER SIMILAR INTAKES ARE AT LEAST 10 FEET FROM EXHAUST END OF SET.
- 7) WEED BARRIER AND 3 INCH THICK GRAVEL BASE OR CONCRETE PAD LOCATED TO PREVENT GRASS & WEEDS FROM GROWING TOO CLOSE TO THE SET.
- 8) NO PLANTS, SHRUBS OR OTHER COMBUSTIBLES ALLOWED IN CLEARANCE AREA. (MINIMUM 4 FT. FROM EXHAUST END).
- 9) REFER TO OWNERS MANUAL FOR OTHER INSTALLATION CONSTRAINTS.
- 10) NO PLANTS, SHRUBS, OR OTHER COMBUSTIBLES ALLOWED WITHIN 30" OF AIR INTAKE.

14/18/20RCA  
SINGLE UNIT  
CONFIGURATION

REV	DATE	CHANGE NUMBER	ON COMPOSITE DWGS, SEE PART NO. FOR REVISION LEVEL □ INDICATES PART NUMBERS AFFECTED BY LATEST DRAWING REVISION	BY
-	04NOV2020	CT207992	NEW DRAWING	AZE

UNLESS OTHERWISE SPECIFIED:  
ALL DIMENSIONS IN MILLIMETERS  
GENERAL TOLERANCES:  
X.XX ± 0.25  
X.X ± 1.0  
X ± 1.5  
ANGLES ± 0°30'

SURFACE FINISH  
MAX.

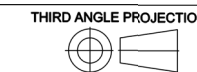

THIRD ANGLE PROJECTION

MAJOR ○ = 0

CRITICAL ⊗ = 0

CHARACTERISTICS COMPLY WITH  
KPS-60022

DRAWN BY AZE

DATE:

APPROVED BY KJB

04NOV2020

DO NOT SCALE.  
THIS ASSEMBLY OR PART MUST COMPLY WITH PEP-RML-001.  
REFERENCE CAD MODEL FOR UNSPECIFIED DIMENSIONS.

**KOHLER.**  
KOHLER, WISCONSIN 53044

SCALE: NA SHEET SIZE: B SHEET 4 OF 5

TITLE:  
**DIMENSION PRINT,  
14/18/20RCA**

DWG NO.: **ADV-9746**

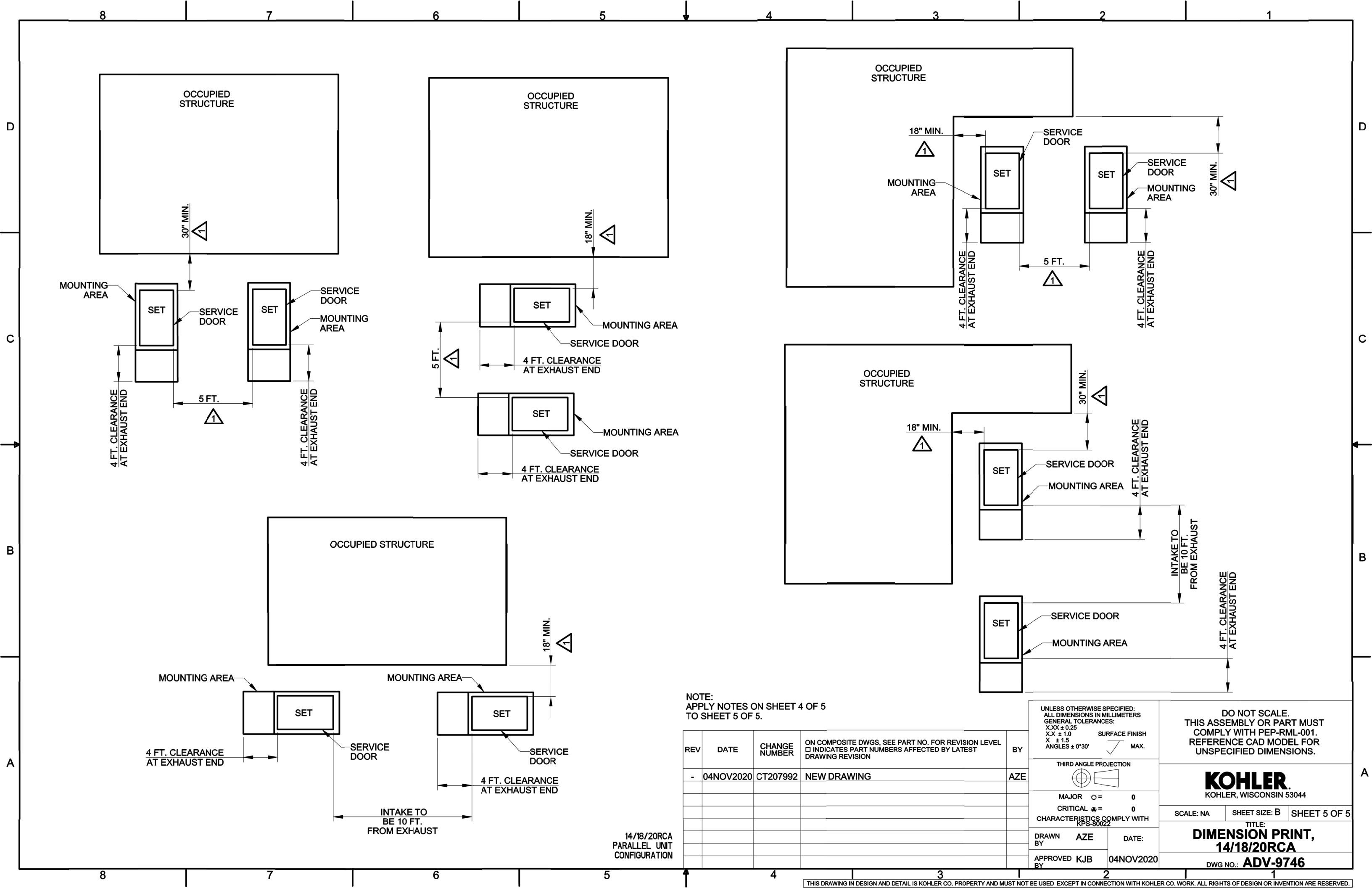

NOTE:  
APPLY NOTES ON SHEET 4 OF 5  
TO SHEET 5 OF 5.

REV	DATE	CHANGE NUMBER	ON COMPOSITE DWGS, SEE PART NO. FOR REVISION LEVEL □ INDICATES PART NUMBERS AFFECTED BY LATEST DRAWING REVISION	BY
-	04NOV2020	CT207992	NEW DRAWING	AZE

UNLESS OTHERWISE SPECIFIED:  
ALL DIMENSIONS IN MILLIMETERS  
GENERAL TOLERANCES:  
X.XX ± 0.25  
X.X ± 1.0  
X ± 1.5  
ANGLES ± 0°30'

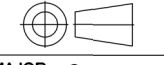
THIRD ANGLE PROJECTION  
  
 MAJOR  $\varnothing = 0$   
 CRITICAL  $\varnothing = 0$   
 CHARACTERISTICS COMPLY WITH  
 KPS-60022  
 DRAWN BY AZE DATE: 04NOV2020  
 APPROVED BY KJB

DO NOT SCALE.  
THIS ASSEMBLY OR PART MUST  
COMPLY WITH PEP-RML-001.  
REFERENCE CAD MODEL FOR  
UNSPECIFIED DIMENSIONS.

**KOHLER.**  
KOHLER, WISCONSIN 53044  
 SCALE: NA SHEET SIZE: B SHEET 5 OF 5  
 TITLE:  
**DIMENSION PRINT,  
 14/18/20RCA**  
 DWG NO.: **ADV-9746**

14/18/20RCA  
PARALLEL UNIT  
CONFIGURATION